

# ARCAM

English

## FMJ A18

**HANDBOOK** Integrated amplifier

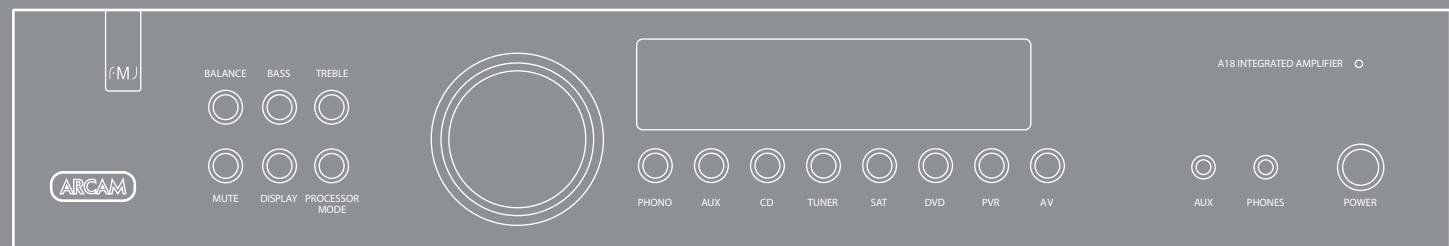

# safety guidelines





**CAUTION**  
RISK OF ELECTRIC SHOCK DO NOT OPEN



**ATTENTION**  
RISQUE DE CHOC ELECTRIQUE NE PAS OUVRIR

**CAUTION:** To reduce the risk of electric shock, do not remove cover (or back). No user serviceable parts inside. Refer servicing to qualified service personnel.

**WARNING:** To reduce the risk of fire or electric shock, do not expose this apparatus to rain or moisture.

The lightning flash with an arrowhead symbol within an equilateral triangle, is intended to alert the user to the presence of uninsulated 'dangerous voltage' within the product's enclosure that may be of sufficient magnitude to constitute a risk of electric shock to persons.

The exclamation point within an equilateral triangle is intended to alert the user to the presence of important operating and maintenance (servicing) instructions in the literature accompanying the product.

**CAUTION:** In Canada and the USA, to prevent electric shock, match the wide blade of the plug to the wide slot in the socket and insert the plug fully into the socket.

## Class II product

 This equipment is a Class II or double insulated electrical appliance. It has been designed in such a way that it does not require a safety connection to electrical earth ('ground' in the U.S.).

## Warning

Mains plug/appliance coupler is used to disconnect device and it shall remain readily operable.

MANY OF THESE ITEMS ARE COMMON SENSE PRECAUTIONS BUT, FOR YOUR OWN SAFETY AND TO ENSURE THAT YOU DO NOT DAMAGE THE UNIT, WE RECOMMEND THAT YOU READ THEM.

## Important safety instructions

This product is designed and manufactured to meet strict quality and safety standards. However, you should be aware of the following installation and operation precautions.

### 1. Take heed of warnings and instructions

You should read all the safety and operating instructions before operating this equipment. Retain this handbook for future reference and adhere to all warnings in the handbook or on the equipment.

### 2. Water and moisture

The presence of electricity near water can be dangerous. To prevent water dripping or splashing into the equipment, do not use near water – for example near a bathtub, kitchen sink or swimming pool, etc.

### 3. Object or liquid entry

Take care that objects do not fall and liquids are not spilled into the enclosure through any openings. Liquid-filled objects such as vases should not be placed on the equipment.

### 4. Placing the equipment

Only use a rack or shelf that is stable and strong enough to support the weight of this equipment.

### 5. Ventilation

Do not block any ventilation openings in the equipment. Do not place the equipment on a bed, sofa, rug or similar soft surface, or in an enclosed bookcase or cabinet, since ventilation may be impeded.

### 5. Heat

Locate the equipment away from naked flames or heat-producing appliances such as radiators, stoves or other appliances that produce heat.

### 6. Climate

The equipment has been designed for use in moderate climates and in domestic situations.

### 8. Cleaning

Unplug the unit from the mains supply before cleaning.

The case should normally only require a wipe with a dry, soft, lint-free cloth. Do not use chemical solvents for cleaning.

We do not advise the use of furniture cleaning sprays or polishes as they can cause permanent white marks.

### 9. Power sources

Only connect the equipment to a power supply of the type described in the operating instructions or as marked on the equipment.

The primary method of isolating the equipment from the mains supply is to remove the mains plug. The equipment must be installed in a manner that makes disconnection possible.

### 10. Power-cord protection

Power supply cords should be routed so that they are not likely to be walked on or pinched by items placed upon or against them. Pay particular attention to the point where they exit from the equipment.

### 11. Non-use periods

We recommend that the power cord of the equipment is unplugged from the power outlet during lightning storms or if the equipment is not being used for an extended period of time

### 12. Abnormal smell

If an abnormal smell or smoke is detected from the equipment, turn the power off immediately and unplug the equipment from the wall outlet. Contact your dealer and do not reconnect the equipment.

### 13. Servicing

You should not attempt to service the equipment. Contact your dealer to arrange servicing.

### 14. Batteries

Batteries should not be exposed to excessive heat (heating systems, sunshine, etc.) or incinerated.

### 15. Damage requiring service

The equipment should be serviced by qualified service personnel when:

- A. the power-supply cord or the plug has been damaged, or
- B. objects have fallen, or liquid has spilled into the equipment, or
- C. the equipment has been exposed to rain or moisture, or
- D. the equipment does not appear to operate normally or exhibits a marked change in performance, or
- E. the equipment has been dropped or the enclosure damaged.

## Safety compliance

This equipment has been designed to meet the IEC/EN 60065 international electrical safety standard.

This device complies with Part 15 of the FCC Rules. Operation is subject to the following two conditions:  
(1) This device may not cause harmful interference, and  
(2) this device must accept any interference received, including interference that may cause undesired operation.

## Contents

<b>safety guidelines</b> .....	<b>E-2</b>
Important safety instructions.....	E-2
Safety compliance.....	E-2
<b>welcome...</b> .....	<b>E-3</b>
<b>overview</b> .....	<b>E-4</b>
Placing the unit .....	E-5
Power .....	E-5
Interconnect cables.....	E-5
<b>A18 connections</b> .....	<b>E-6</b>
Pre-amplifier connection .....	E-7
Audio inputs.....	E-7
Recording loops.....	E-7
Phono input.....	E-7
<b>loudspeakers</b> .....	<b>E-8</b>
Single wiring .....	E-8
Bi-amping.....	E-8
<b>remote control</b> .....	<b>E-9</b>
The CR10 remote control .....	E-9
Amplifier commands.....	E-9
Switching on .....	E-10
Selecting an audio source .....	E-10
Listening .....	E-10
<b>operation</b> .....	<b>E-10</b>
Adjusting listening settings.....	E-10
Processor mode .....	E-10
Recording an audio source .....	E-11
Troubleshooting .....	E-11
<b>specifications</b> .....	<b>E-12</b>
<b>product guarantee</b> .....	<b>E-13</b>

*Thank you and congratulations for purchasing your Arcam FMJ Amplifier.*

*Arcam has been producing specialist audio products of remarkable quality for over three decades and the new A18 amplifier is the latest in a long line of award winning HiFi. The design of the FMJ range draws upon all of Arcam's experience as one of the UK's most respected audio companies, to produce Arcam's best performing range of stereo amplifiers yet – designed and built to give you years of listening enjoyment.*

*This handbook is a guide to installing and using the A18 Integrated Amplifier, including information on the more advanced features. Use the contents list shown on this page to guide you to the section of interest.*

*We hope that your FMJ amplifier will give you years of trouble-free operation. In the unlikely event of any fault, or if you simply require further information about Arcam products, our network of dealers will be happy to help you. Further information can also be found on the Arcam website at [www.arcam.co.uk](http://www.arcam.co.uk).*

**The FMJ development team**

welcome...

English

## overview

Arcam's A18 Integrated Amplifier provides class-leading sound quality.

Drawing on the many years of amplifier design experience at Arcam, the A18 uses the best quality components and engineering practice to produce a product that will give many years of musical pleasure and reliable service.

With a torrodial power supply, acoustically damped chassis and very low levels of noise and distortion, the A18 reproduces music with all its original authority and detail.

**The A18 Integrated Amplifier is designed to produce a level of performance that will truly bring music to life.**



## Placing the unit

- Place the amplifier on a level, firm surface, avoiding direct sunlight and sources of heat or damp.
- Do not place the A18 on top of a power amplifier or other source of heat.
- Do not place the amplifier in an enclosed space such as a bookcase or closed cabinet unless there is good provision for ventilation. The A18 is designed to run warm during normal operation.
- Do not place any other component or item on top of the amplifier as this may obstruct airflow around the heat-sink, causing the amplifier to run hot. (The unit placed on top of the amplifier would become hot, too.)
- Make sure the remote-control receiver to the right of the front panel display is unobstructed, otherwise this will impair the use of the remote-control.
- Do not place your record deck on top of this unit. Record decks are very sensitive to the noise generated by mains power supplies which will be heard as a background 'hum' if the record deck is too close.

## Power

The amplifier is supplied with a moulded mains plug already fitted to the lead. Check that the plug supplied fits your supply – should you require a new mains lead, please contact your Arcam dealer.

If your mains supply voltage or mains plug is different, please contact your Arcam dealer immediately

Push the IEC plug end of the power cable into the socket on the back of the amplifier, making sure that it is pushed in firmly. Plug the other end of the cable into your mains socket and, if necessary, switch the socket on.

## Interconnect cables

We recommend the use of high-quality screened cables that are designed for the particular application. Other cables will have different impedance characteristics that will degrade the performance of your system (for example, do not use cabling intended for video use to carry audio signals). All cables should be kept as short as is practically possible.

It is good practice when connecting your equipment to make sure that the mains power-supply cabling is kept as far away as possible from your audio cables. Failure to do so may result in unwanted noise in the audio signals.

# A18 connections

## Power inlet

Connect the correct mains cable here.

## Speaker terminals

See page 8 for information on connecting loudspeakers.

## Phono earth terminal

For connecting your turntable earth lead, if required. Note that this terminal must not be used as a safety earth.

## Aux input

Analogue 3.5mm stereo jack socket, intended for connecting a portable MP3 player.

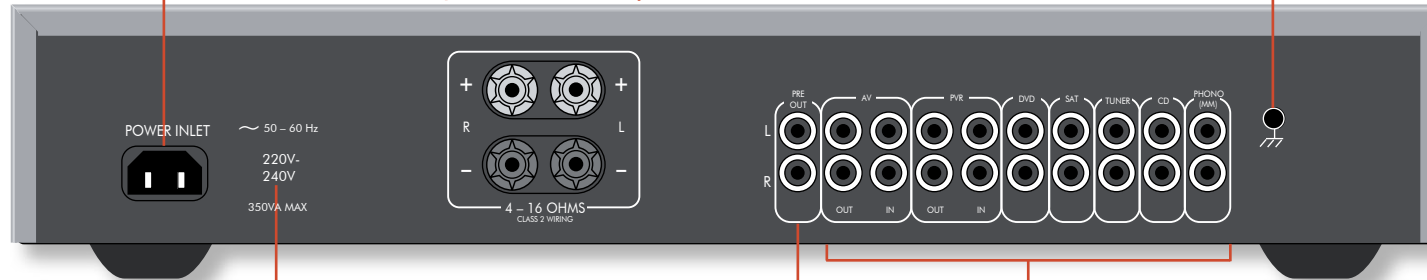

## Mains voltage

Ensure that the voltage indicated matches your local power supply. If not, please contact your dealer.

## Pre-amplifier connection

This socket is only used if you are using the A18 as a pre-amp, for example, when using the A18 in conjunction with a P38. See page 8 for more information.

## Audio connections

The labels above the connectors give suggested audio inputs, although any suitable device may be connected to the line-level inputs. (Note, however, that the name of the input shown on the front-panel display cannot be changed.)

DVD, SAT, TUNER and CD are all line-level inputs. The PHONO (MM) input has different characteristics – see page 12 for the specification.

In addition to the line level inputs, the AV and PVR connectors both have line level *outputs* for use in recording from other sources.

See page 7 for more information.

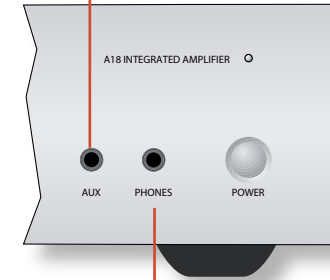

## Phones

3.5mm stereo jack socket, intended for use with a set of headphones.

## Note

Please read the 'Placing the unit', 'Power' and 'Interconnect cables' sections on page 5 before connecting up your A18 integrated amplifier!

## Pre-amplifier connection

### PRE OUT

To use your A18 as a dedicated pre-amplifier, or as part of a bi-amped system, connect the **PRE OUT** sockets to the input sockets of your power amplifier.

## Audio inputs

Although the inputs are labelled for specific devices, all have the same characteristics and each may be used with any line-level product. The exception is the **PHONO (MM)** input (see page 12 for the specification).

### AV IN

Intended for the analogue outputs from general audio-visual equipment, such as a VCR, digital TV/satellite receiver, or Nicam tuner.

### PVR IN

Intended for the analogue outputs from a Personal Video Recorder, or similar device.

### DVD

Intended for the analogue outputs from a DVD-player.

### SAT

For connection to a satellite TV receiver or cable box.

### TUNER

Intended for the analogue outputs from an FM, AM or DAB radio tuner.

### CD

Intended for the analogue outputs from a CD player.

### AUX

This is a 3.5mm analogue input on the front panel intended for use with devices such as MP3 players. To connect an MP3 player (or other portable audio device) you will need a 3.5mm to 3.5mm cable connected between the **AUX** input and the headphone socket of the device.

## Recording loops

The A18 is equipped with two recording loops: AV and PVR. These are for use with recording devices – such as a CD recorder, DAT recorder, cassette recorder, VCR, PVR, etc. The AV outputs may have any of the input connectors assigned to them for recording purposes.

### AV OUT

Connect these output sockets to the input sockets of your recording device (usually labelled **RECORD** or **IN**).

To record from a particular source, press the appropriate source button (for example, **TUNER**), then press **AV**. Any source selected immediately before **AV** is routed to the **AV OUT** connectors for recording purposes and is shown on the front panel (e.g. **RC TUNER**).

### PVR OUT

The **PVR OUT** also has the source selected immediately before **AV** routed to it, unless that source is **PVR IN**, in which case **PVR OUT** is muted. As with **AV OUT**, changing to another source will change the signal that is sent to **PVR OUT**.

## Phono input

The phono inputs provide a pre-amplification stage to treat the low-voltage output from a moving magnet cartridge (input specifications are given on page 12). If you have already an external phono amplifier that you wish to use, connect its output to one of the line-level inputs.

# loudspeakers

## Single wiring

Single wiring is the conventional wiring method of running a single cable per channel between the amplifier and the speaker; this is the easiest technique.

If each speaker has more than one pair of connecting terminals, use the terminals labelled LF or 'Low Frequency' for each speaker.

Connect the positive terminal of the right speaker connection on the amplifier (coloured red and labelled +R) to the positive terminal of your right speaker.

Similarly, connect the negative terminal of the amplifier (coloured black and labelled with R-) to the negative terminal of your speaker. Repeat the process for the left speaker, using the amplifier terminals labelled +L and L-.

If your speakers support bi-wiring, then there is a strip of conductive metal on the speakers connecting the low-frequency terminals to those for the higher-frequencies; this **MUST NOT BE REMOVED** in a single-wired system.

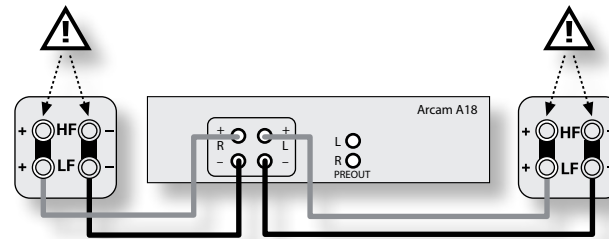

An A18 connected to speakers using single wiring

## Notes on making speaker connections

- Do not make any connections to any amplifier while it is switched on. We recommend that your amplifier is completely disconnected from the mains supply before starting.
- Before switching your amplifier(s) on for the first time after connecting to speakers, please check all connections thoroughly. Ensure that bare wires or cables are not touching each other or the amplifier's chassis (which could cause short circuits), and that you have connected positive (+) to positive and negative (-) to negative. Be sure to check the wiring for both the amplifier **and** the speaker.
- After making connections: switch the amplifier(s) on, select a source signal, then gradually increase the volume to the required listening level.
- If you are unsure as to how your system should be connected, or need advice on bi-amping, please contact your Arcam dealer who will be happy to help you.

## Bi-amping

Bi-amping is the separation of the amplification of low- and high-frequency signals over two amplifiers.

Bi-amping requires the use of two amplifiers per channel. Normally, your A18 is used to drive the high-frequency (treble) speakers, with a P38 used for the lower (bass) frequencies.

Connect your A18 to the speakers as described for single wiring, with the exception that the A18 should be connected to the speaker terminals labelled HF or 'High Frequency'. Then connect the power amplifier (an Arcam P38 for example) to the LF or 'Low Frequency' terminals, as in the diagram. A pair of audio interconnect cables are also required to connect the pre-amp outputs of the A18 to the power amp inputs of the P38.

Note that the strip of metal on the speakers connecting the lower terminals to the upper terminals **MUST BE REMOVED**. Failure to do so will result in damage to both amplifiers, which will not normally be covered under warranty.

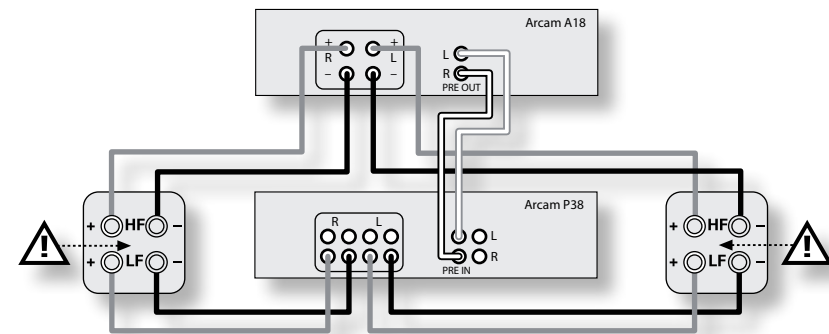

An A18 and P38 connected to speakers using bi-amping



# remote control

## The CR10 remote control

The CR10 is pre-programmed for use with the A18 as well as Arcam CD players (such as CD17).

The CR10 requires a clear line of sight to the front panel display of A18 to ensure reliable operation. Make sure you have inserted the two AAA batteries supplied before attempting to use the CR10.

Keys on the CR10 that control the A18 are shown not greyed-out.

### Inserting batteries into the remote control

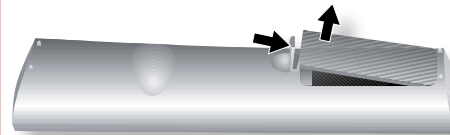

1. Squeeze the tab and lift off the remote control's battery compartment cover.

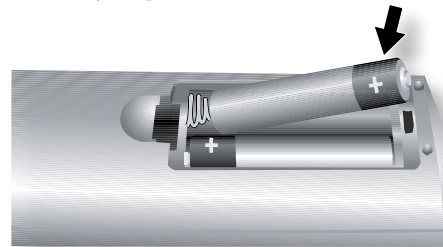

2. Insert the two 'AAA' batteries supplied in the proper direction, following the '+' and '-' marks in the battery compartment.

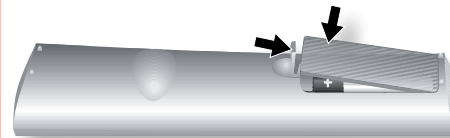

3. Replace the battery compartment cover, locking the tab with a click.



## Amplifier commands

	Toggles the mute function to silence speaker output. <i>MUTE</i> is displayed on screen when active.
<b>VOL -</b> <b>VOL +</b>	Decrease ( <b>VOL-</b> ) and increase ( <b>VOL+</b> ) amplifier volume
<b>Source keys</b>	Selects the amplifier input: <b>DVD</b> DVD input <b>SAT</b> Satellite decoder input <b>AV</b> AV (television sound) input <b>TUN</b> DAB/FM/AM tuner input <b>AUX</b> Auxiliary line input <b>PVR</b> Personal Video Recorder input <b>CD</b> CD input <b>PHO</b> Phono input
<b>BASS</b>	Adjust bass levels (using <b>VOL-</b> and <b>VOL+</b> controls) between -7, through 0, to +7
<b>TREB</b>	Adjust treble levels (using <b>VOL-</b> and <b>VOL+</b> controls) between -7, through 0, to +7
<b>BAL</b>	Adjust balance levels (using <b>VOL-</b> and <b>VOL+</b> controls) between L (left) 9, through 0, to R (right) 9
<b>PROC</b>	Toggles between PROC ON and OFF. PROC mode is only available if the <b>AV</b> input is selected  When in PROC mode, the <b>VOL-</b> and <b>VOL+</b> can be used to adjust the PROC volume setting.
<b>DRCT</b>	Toggles direct mode (i.e. tone defeat)
<b>DISP</b>	Cycles through display panel brightness options (bright, off, dim)
<b>MODE</b>	Cycles through displaying the settings for Bass, Treble and Balance

# operation



## Switching on

The front panel **POWER** button switches the unit on and off.

The power light (next to the 'A18 Integrated Amplifier' text) indicates the state of the amplifier. The power LED is green and ON if the power is connected and the unit is turned ON.

## Display

The front panel **DISPLAY** button (or **DISP** on the remote control) changes the display brightness between 'on', 'dimmed' and 'off'. If the A18 is powered off with the display brightness set to 'off', the display resumes to 'dimmed' when the unit is powered on again.

## Selecting an audio source

The audio source may be selected from the front panel (**PHONO**, **AUX**, **CD**, **TUNER**, **SAT**, **DVD**, **PVR** or **AV**), or the remote control (**DVD**, **SAT**, **AV**, **TUN**, **AUX**, **PVR**, **CD** or **PHO**).

In each case, the source is selected from the input sockets with the corresponding name.

## Listening

### Listening using speakers

Use the control knob to change the volume. Turn the knob clockwise to increase the volume, anti-clockwise to reduce it.

### Listening using headphones

The headphones socket (**PHONES**) accepts headphones with an impedance rating between 8Ω and 2kΩ, fitted with a 3.5mm stereo jack plug.

The pre-amp outputs and speakers are muted when headphones are plugged in. The headphones socket is always active, unless output has been muted.

### Muting output

The output of the A18 can be silenced by pressing **MUTE** on the front panel (or **M** on the remote control). Press **MUTE**/**M** for a second time (or change the volume) to cancel mute.

## Adjusting listening settings

The A18 allows you to customise the balance, bass and treble levels of the amplifier to fit your system. Adjustments can be made either on the front panel or by using the CR10 remote control. Click the corresponding button to view the current setting, then use the control knob on the front panel (or **VOL +/-** buttons on the CR10) to adjust.

### Balance

This setting allows you to increase the volume of one channel (left or right) relative to the other. Altering the balance (from **LS** to **RS**, via the neutral value **0**) may help to restore the stereo image for an off-centre listening position.

### Bass

This setting allows you to increase or decrease the level of low frequency elements in the sound within the range **+7** to **-7**.

### Treble

This setting allows you to increase or decrease the level of high frequency elements in the sound within the range **+7** to **-7**.

### Direct mode

This is a 'tone defeat' setting which ignores any Bass and Treble trim values.

Press **DRCT** (Direct) on the remote control to toggle this setting; **'DIRECT'** is lit on the display when Direct mode is active.

## Processor mode

The A18, in combination with a power amplifier, can be used to drive the front left and right speakers of a surround-sound system, when fed from a multi-channel processor. The volume of the entire system may then be controlled using the processor.

While in Processor mode, you can feed the sound from the processor into **AV IN** and set the 'Proc mode volume' of the A18 to match the amplifiers that drive your other loudspeakers. Set this 'Proc mode volume' using the **VOL+** and **VOL-** buttons on the remote. The last set value of 'Proc mode volume' is remembered whenever Processor mode is selected.

Processor mode may be toggled on and off (when **AV** is selected as the source) by using the front panel **PROCESSOR MODE** button or **PROC** on the remote. **'PROC'** remains lit on the display while Processor mode is active.

## Recording an audio source

The A18 allows you to record and monitor the sound from any connected source.

The back panel **AV OUT** or **PVR OUT** sockets can be connected to the input sockets of your recording device (these are usually labelled **RECORD** or **IN**). The two recording loops have a similar function to each other, but are not exactly the same in operation.

To record from a particular source, press the appropriate source button (for example, **TUNER**), then press **AV**. Any source selected immediately before **AV** is routed to the **AV OUT** connectors for recording purposes and is shown on the front panel (e.g. **RC TUNER**).

The **PVR OUT** also has the source selected immediately before **AV** routed to it, unless that source is **PVR IN**, in which case **PVR OUT** is muted. As with **AV OUT**, changing to another source will change the signal that is sent to **PVR OUT**.

## Troubleshooting

If you are having trouble with your amplifier, check the following items.

### No sound

Check the following:

- The A18 amplifier is powered up and switched on.
- The amplifier is not muted (i.e. **MUTE** is not shown on the display panel).
- The selected source is generating audio (e.g., if CD is selected, then the CD is playing).
- The AV input is selected on the A18 instead of the expected source. If there is no sound because the AV input is selected, press the correct source button on the front panel or remote control.
- The speaker outputs are connected on the A18 (or on the power amplifier, in the case of a bi-amping arrangement).

### Sound cuts-out unexpectedly

If the temperature of the internal heatsink rises above a safe level, then a thermal cut-out inside the amplifier operates to protect the unit and the protection system temporarily removes power to the speakers. The system will reset itself as the heatsink cools down.

- With two pairs of low-impedance speakers connected ( $6\Omega$  or less), overloads are more likely. Overloading the amplifier may cause it to shut down because of overheating.
- Note that, due to the high output voltage from a CD player, it is possible to drive your amplifier at full power even though the volume is not set at maximum.

# specifications

<b>Continuous power output (20Hz—20kHz at 0.5% THD), per channel</b>	
Both channels, 8Ω, 20Hz—20kHz	50W
Single channel, 4Ω, at 1kHz	70W
Harmonic distortion, 80% power, 8Ω at 1kHz	0.01%
<b>Inputs</b>	
Phono cartridge:	
Input sensitivity at 1kHz	2.5—15mV
Input impedance	47kΩ
Signal/noise ratio (CCIR, 45W)	88dB
Overload margin	31dB
Line and AV inputs:	
Nominal sensitivity	250mV—1.5V
Input impedance	22kΩ
Signal/noise ratio (CCIR, 45W)	98dB
<b>Preamplifier output</b>	
Nominal output level	630mV
Output impedance	<50Ω
<b>Headphone output</b>	
Maximum output level into 600Ω	7V
Output impedance	100Ω
<b>General</b>	
Mains voltage	110—120V or 220—240V
Power consumption (maximum)	350W
Dimensions W x D x H (including feet)	432 x 275 x 85mm
Weight (net)	7.2kg
Weight (packed)	9.1kg
Supplied accessories	mains lead CR10 remote control 2 x AAA batteries
E&OE	
<b>NOTE:</b> All specification values are typical unless otherwise stated.	

### Continual improvement policy

Arcam has a policy of continual improvement for its products. This means that designs and specifications are subject to change without notice.

## product guarantee

### Worldwide Guarantee

This entitles you to have the unit repaired free of charge, during the first two years after purchase, at any authorised Arcam distributor provided that it was originally purchased from an authorised Arcam dealer or distributor. The manufacturer can take no responsibility for defects arising from accident, misuse, abuse, wear and tear, neglect or through unauthorized adjustment and/or repair, neither can they accept responsibility for damage or loss occurring during transit to or from the person claiming under the guarantee.

#### The warranty covers:

Parts and labour costs for two years from the purchase date. After two years you must pay for both parts and labour costs. **The warranty does not cover transportation costs at any time.**

### Claims under guarantee

This equipment should be packed in the original packing and returned to the dealer from whom it was purchased, or failing this, directly to the Arcam distributor in the country of residence.

It should be sent carriage prepaid by a reputable carrier – **not** by post. No responsibility can be accepted for the unit whilst in transit to the dealer or distributor and customers are therefore advised to insure the unit against loss or damage whilst in transit.

For further details contact Arcam at:

Arcam Customer Support Department,  
Pembroke Avenue, Waterbeach, CAMBRIDGE, CB25 9QR, England

or via [www.arcam.co.uk](http://www.arcam.co.uk).

### Problems?

If your Arcam dealer is unable to answer any query regarding this or any other Arcam product please contact Arcam Customer Support at the above address and we will do our best to help you.

### On-line registration

You can register your product on-line at [www.arcam.co.uk](http://www.arcam.co.uk).

#### Correct disposal of this product



This marking indicates that this product should not be disposed with other household waste throughout the EU.

To prevent possible harm to the environment or human health from uncontrolled waste disposal and to conserve material resources, this product should be recycled responsibly.

To dispose of your product, please use your local return and collection systems or contact the retailer where the product was purchased.

# ARCAM