

Arcam A70 amplifier

English

Amplificateur Arcam A70

Français

Arcam-Verstärker A70

Deutsch

Arcam-versterker A70



Nederlands

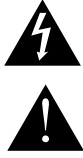

ARCAM

Safety guidelines



	CAUTION RISK OF ELECTRIC SHOCK DO NOT OPEN	ATTENTION RISQUE DE CHOC ELECTRIQUE NE PAS OUVRIR	
---	--	---	---

CAUTION: To reduce the risk of electric shock, do not remove cover (or back). No user serviceable parts inside. Refer servicing to qualified service personnel.

WARNING: To reduce the risk of fire or electric shock, do not expose this apparatus to rain or moisture.

The lightning flash with an arrowhead symbol within an equilateral triangle, is intended to alert the user to the presence of uninsulated 'dangerous voltage' within the product's enclosure that may be of sufficient magnitude to constitute a risk of electric shock to persons.

The exclamation point within an equilateral triangle is intended to alert the user to the presence of important operating and maintenance (servicing) instructions in the literature accompanying the product.

CAUTION: In Canada and the USA, to prevent electric shock, match the wide blade of the plug to the wide slot in the socket and insert the plug fully into the socket.

Important safety instructions

This product is designed and manufactured to meet strict quality and safety standards. However, you should be aware of the following installation and operation precautions:

1. Take heed of warnings and instructions

You should read all the safety and operating instructions before operating this appliance. Retain this handbook for future reference and adhere to all warnings in the handbook or on the appliance.

2. Water and moisture

The presence of electricity near water can be dangerous. Do not use the appliance near water – for example next to a bathtub, washbowl, kitchen sink, in a wet basement or near a swimming pool, etc.

3. Object or liquid entry

Take care that objects do not fall and liquids are not spilled into the enclosure through any openings. Liquid filled objects such as vases should not be placed on the equipment.

4. Ventilation

Do not place the equipment on a bed, sofa, rug or similar soft surface, or in an enclosed bookcase or cabinet, since ventilation may be impeded. The unit should be installed in a well-ventilated area.

5. Heat

Locate the appliance away from naked flames or heat producing equipment such as radiators, stoves or other appliances (including other amplifiers) that produce heat.

6. Climate

The appliance has been designed for use in moderate climates.

7. Racks and stands

Only use a rack or stand that is recommended for use with audio equipment. If the equipment is on a portable rack it should be moved with great care, to avoid overturning the combination.

8. Cleaning

Unplug the unit from the mains supply before cleaning.

The case should normally only require a wipe with a soft, damp, lint-free cloth. Do not use paint thinners or other chemical solvents for cleaning.

We do not advise the use of furniture cleaning sprays or polishes as they can cause indelible white marks if the unit is subsequently wiped with a damp cloth.

9. Power sources

Only connect the appliance to a power supply of the type described in the operating instructions or as marked on the appliance.

Warning: This is a Class I device and **must** be earthed.

Warning: The mains plug is used as the disconnect device from the mains supply and shall remain readily operable.

10. Power-cord protection

Power supply cords should be routed so that they are not likely to be walked on or pinched by items placed upon or against them, paying particular attention to cords and plugs, and the point where they exit from the appliance.

11. Grounding

Ensure that the grounding means of the appliance is not defeated.

12. Power lines

Locate any outdoor antenna/aerial away from power lines.

13. Non-use periods

If the unit has a stand-by function, a small amount of current will continue to flow into the equipment in this mode. Unplug the power cord of the appliance from the outlet if left unused for a long period of time.

14. Abnormal smell

If an abnormal smell or smoke is detected from the appliance, turn the power off immediately and unplug the unit from the wall outlet. Contact your dealer immediately.

15. Servicing

You should not attempt to service the appliance beyond that described in this handbook. All other servicing should be referred to qualified service personnel.

16. Damage requiring service

The appliance should be serviced by qualified service personnel when:

- A. the power-supply cord or the plug has been damaged, or
- B. objects have fallen, or liquid has spilled into the appliance, or
- C. the appliance has been exposed to rain, or
- D. the appliance does not appear to operate normally or exhibits a marked change in performance, or
- E. the appliance has been dropped or the enclosure damaged.

17. Speaker connections

Any speakers must be connected to the A70 using Class 2 wire (i.e., no connection to earth should be made). Failure to observe this precaution may cause the unit to be damaged.

Safety compliance

This product has been designed to meet the IEC 60065 international electrical safety standard.

Using this handbook

This handbook has been designed to give you all the information you need to install, connect, set up and use the Arcam A70 amplifier. The CR-389 remote control handset supplied with the A70 amplifier is also described.

Your amplifier may have been installed and set up by an authorised Arcam dealer. In this case, you may wish to go directly to the sections describing the use of this equipment.

Safety

Safety guidelines are set out on the inside front cover of this handbook.

Many of these items are common sense precautions, but for your own safety, and to ensure that you do not damage the unit, we strongly recommend that you read them.

Contents

Safety guidelines	E-2
Important safety instructions	E-2
Safety compliance.....	E-2
Using this handbook	E-3
Safety	E-3
Installation	E-4
Positioning the unit	E-4
Connecting to loudspeakers	E-4
Connecting to a power supply.....	E-4
Connecting to other equipment.....	E-5
Using your A70 amplifier	E-6
Front panel controls	E-6
Recording	E-7
Setting up your A70 amplifier	E-8
Using the remote control	E-9
CR-389 Remote Control	E-9
Bi-wiring and bi-amping loudspeakers	E-10
Before you start	E-10
Bi-wiring your loudspeakers	E-10
Bi-amping your system.....	E-10
Service information	E-11
Sound cuts out unexpectedly.....	E-11
Technical specifications	E-11
Remote-control codes	E-12
Guarantee	E-12
Worldwide Guarantee	E-12
On-line registration	E-12

Installation

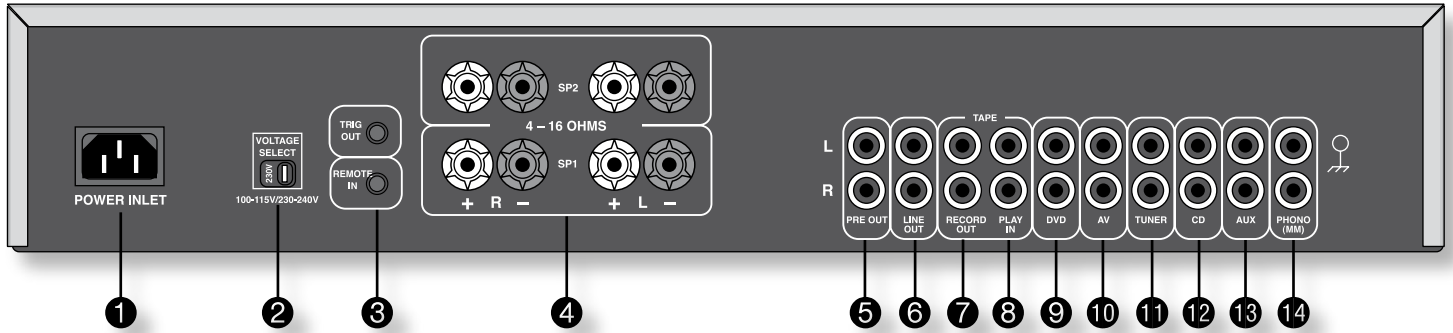

Positioning the unit

Place your amplifier on a level, firm surface. Avoid placing the unit in direct sunlight or near sources of heat or damp.

Ensure adequate ventilation. Do not place the unit in an enclosed space such as a bookcase or cabinet as both of these will impede air flow through the ventilation slots.

Connecting to loudspeakers

You can connect one or two pairs of loudspeakers to your amplifier, provided each pair is rated between 8–16Ω. If one or both pairs have an impedance of less than 8Ω, the combined load on the amplifier falls below 4Ω and could cause an overload. If so, the overload protection circuit may engage and the amplifier will not work.

To connect one pair of loudspeakers, use the **SP1** terminals.

Caution: Do not over tighten the loudspeaker terminals or use a wrench, pliers, etc., as this could cause damage to the terminals which will not be covered under warranty.

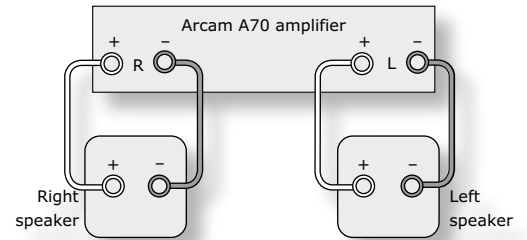

Wiring your loudspeakers

SP1 and SP2 terminals ④

Both sets of loudspeaker terminals can be muted by pressing the **MUTE** button on the remote control. To switch SP1 and SP2 independently, use the front panel switches (see page 6, ②) or the remote control (see page 9).

Your amplifier is fitted with industry standard loudspeaker terminals. The terminal accepts spade terminals or bare wires.

To connect a spade terminal or bare wire, unscrew the red (or black) part of the loudspeaker terminal first. Insert the wire or spade terminal and screw it back up.

Connect the right speaker to the terminals on the back of your amplifier marked **R** and the left speaker to the terminals marked **L**.

Connect your loudspeakers so that the red (positive/+) terminal on each loudspeaker is connected to the red (positive/+) terminal on the amplifier. Your loudspeaker cables may be marked to show polarity (negative/– and positive/+), if not, then the positive terminal can usually be identified by a ridge or coloured marking.

Now connect your loudspeakers' black (negative/–) terminals to the black (negative/–) terminals on the amplifier. Ensure that no stray strands of inner wires are allowed to touch another cable or the amplifier's casing. This can cause a short circuit and damage your amplifier!

Connecting to a power supply

Mains lead

The appliance is normally supplied with a moulded mains plug already fitted to the lead. If for any reason the plug needs to be removed, it must be disposed of immediately and securely, as it is a potential shock hazard when inserted into the mains socket. Should you require a new mains lead, contact your Arcam dealer.

Wrong plug?

Check that the plug supplied with the unit fits your supply and that your mains supply voltage agrees with the voltage setting (**115V** or **230V**) indicated on the rear panel of the unit ② before plugging in.

If your mains supply voltage or mains plug is different, consult your Arcam dealer or Arcam Customer Support on +44 (0)1223 203200.

The product must be earthed.

Plugging in

Push the plug (IEC line socket) of the power cable supplied with the unit into the socket (**POWER INLET**) ① in the back of the unit. Make sure it is pushed in firmly.

Put the plug on the other end of the cable into your power supply socket and switch the socket on.

Standby power

For remote standby operation, the amplifier's control power supply is kept powered up all the time the unit is connected to the mains supply. The front panel power switch powers down all other circuitry. Power consumption in this mode is less than 2.5W.

This means that even though the power switch is off, it may be possible to hear a slight hum coming from the mains transformer inside the amplifier. This is perfectly normal. If the unit is to be left unused for an extended period, we recommend that it is disconnected from the mains supply by switching it off at the wall socket, or by disconnecting the power lead.

Connecting to other equipment

The use of high quality interconnect cables to and from your amplifier is recommended to ensure the best sound quality. Sockets marked **L** (and **R**) on your amplifier should only be connected to sockets marked **L** (and **R**) on other equipment. All the line inputs have the same sensitivity and may be used with equipment other than that labelled, if needed.

LINE OUT 6 – Connect this output to the audio inputs of any unit with a line-level input, e.g., tape deck, etc.

TAPE/RECORD OUT 7 – Connect these output sockets to the input sockets of your cassette deck (usually labelled **RECORD**).

TAPE/PLAY IN 8 – Connect these input sockets to the output sockets of your cassette deck (usually labelled **PLAY**). If you do not have a cassette deck you can use this input for other (line level) equipment, such as a CD player, tuner, VCR, etc., but not a turntable.

DVD 9 – Connect this input to the audio outputs of a DVD player.

AV 10 – Connect this input to the audio outputs of audiovisual equipment such as a VCR, laserdisc player, satellite or Nicam tuner.

TUNER 11 – Connect this input to the audio outputs of your radio tuner.

CD 12 – Connect this input to the audio outputs of your CD player or DAC (digital to analogue converter).

AUX 13 – Connect this input to the audio outputs of any unit with a line level output, e.g. tape deck, tuner, etc.

PHONO 14 – Connect this input to the output of your record player. This input provides RIAA equalization and is compatible with most high output moving magnet (**MM**) cartridges.

Phono earth terminal – For connecting your turntable earth lead (if fitted). Note that this terminal must not be used as a safety earth.

TRIG OUT and REMOTE IN 3 (12V in and out) – Each socket accepts a 3.5mm Mono Jack, with Tip=signal, Sleeve=ground. The connections are intended for use in multi-room installations.

TRIG OUT – This output provides a 12V signal whenever the unit is switched on (i.e., not off or in standby). This signal can be used to switch on automatically power amplifiers (or other equipment) connected to the A70, as they will come on when the A70 is activated. This is useful if the power amplifier is remote from the A70, or otherwise difficult to access. If you are bi-amping with a power amplifier and wish to power both units on or off simultaneously, see page 10.

REMOTE IN – This allows remote control signals to be received by the A70 if the remote sensor is covered (or otherwise not 'visible' to the remote control). An external sensor is used to receive the signals from the remote control, which are then fed to the A70 (into this input) using a suitable cable. Remote control signals acceptable to the A70 must be in modulated RC5 format, with a voltage level of between 5V and 15V.

Note that in normal use there is no need to make any connections to these sockets. If you would like to make use of these features, please contact your dealer for more advice on how to make the connections and on what type of cable to use.

Pre/power amplifier connections

If you wish to use your A70 as a power amplifier, please consult your Arcam dealer.

PRE OUT 5 – To use your amplifier as a pre-amplifier, connect the **PRE OUT** sockets to the input sockets of your power amplifier. With a power amplifier of the correct gain (e.g. an Arcam P90 power amplifier) you can bi-amplify ('bi-amp') suitable loudspeakers, giving significant improvements in sound quality (see page 10).

The different output types

The distinction between **PRE OUT**, **LINE OUT** and **RECORD OUT** output types is subtle but important.

PRE OUT: This is the output that should be connected to your power amplifier. The output level varies with the volume control.

LINE OUT: This output is taken before the volume control, i.e., the source being listened to is routed directly to this output. If you wish, this output may be connected to a recording device, such as a cassette recorder. Under no circumstances should this output be connected to a power amplifier.

RECORD OUT: The output from the **RECORD OUT** connectors is dependent on the configuration of the amplifier. Full instructions for this output are given on page 7; briefly, if the amplifier is configured to **REC SOURCE**, then this output will carry the same signal as the **LINE OUT** connection. If the amplifier is configured so that you are recording a different source than the one you are listening to, then the **RECORD OUT** connections will carry the source being recorded.

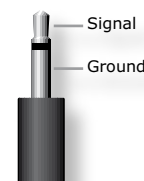

3.5mm Mono Jack

Using your A70 amplifier

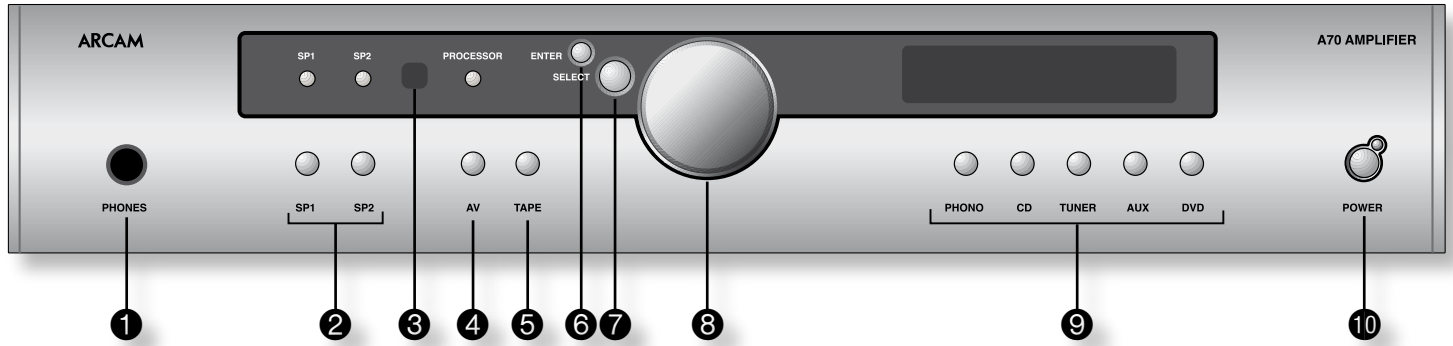

Front panel controls

This section describes how to operate your amplifier.

If you are installing the amplifier yourself, you should first read the 'Installation' section on page 4.

POWER (and power indicator light) 10

Switches the unit on and off. (You can also switch the amplifier into standby mode with the remote control handset.)

The light indicates the status of the amplifier. A red light means the amplifier is in standby mode (press the **POWER/STANDBY** button on the remote control, or the **POWER** button on the front panel, to switch between standby and powered-up modes).

When you switch your amplifier on, the light glows amber for a few seconds, during which time the speakers are disconnected. The light changes to green when the amplifier is ready for use.

The light may flash if a fault has occurred – the fault type is shown on the display. You should unplug the amplifier and leave it for a few minutes before reconnecting. If the fault cannot be cleared, unplug your amplifier and contact your Arcam dealer.

Source selectors 9

These buttons select the source connected to the corresponding input. The input currently selected is indicated by text on the display.

AV 4

This input is similar to the other line level inputs on the amplifier and may be used with a VCR or a second recording unit (e.g. cassette deck).

Control knob, SELECT and ENTER 8 7 6

The control knob has two functions:

- as a volume control, to adjust the output of loudspeakers and headphones connected to the amplifier, and of the pre-amp output (**PRE OUT**).
- when used in conjunction with the **SELECT** and **ENTER** buttons, to customise amplifier settings (see page 8).

Volume control settings

It is important to realise that the position of the Control knob is not an accurate indication of the power delivered to your loudspeakers. The amplifier often delivers its full power before the volume control reaches its maximum position, particularly when listening to heavily recorded compact discs. However the amplifier also has to be capable of giving full power output from much lower level sources, such as tuners and cassette decks. Using these sources, the volume control setting may be much higher before distortion (audible overload) sets in. To compensate for this, the input levels of each source may be individually adjusted to avoid accidental overload (see page 8).

SP1 and SP2 2

These buttons allow you to select and deselect the main (**SP1**) and secondary (**SP2**) set of speakers attached to your amplifier.

The light above each button glows if the corresponding speakers are currently selected. If both lights are out the amplifier will appear not to work, as all speakers are switched off!

PHONES 1

This socket accepts headphones with an impedance rating between 8Ω and 2kΩ, fitted with a 1/4-inch stereo jack plug. If you wish to listen on headphones only, use the **SP1** and **SP2** buttons (if necessary) to mute the speakers. The headphone socket is always active.

Remote control receiver 3

The remote control's infrared receiver is positioned between the **SP1/SP2** and **PROCESSOR** indicator lights on the left-hand side of the front panel window. Ensure the receiver is in a clear line of sight from the remote control to allow signals to be received.

Recording

With the Arcam A70 it is possible to listen and to record from one source, or to listen to one source while recording another.

The record signal is sent to the **TAPE** output sockets. These sockets are suitable for use with almost any type of recorder (cassette, CDR, MD, VCR, reel-to-reel, etc.).

To record the currently selected source, press the **SELECT** button to enter the menu system. Rotate the Control knob clockwise until the display shows 'REC OUTPUT'. Press **SELECT**. 'REC' is displayed, followed by the current setting. Rotate the Control knob counter-clockwise until 'REC SOURCE' is displayed. After a few seconds, the display reverts to showing the volume level and you are ready to record.

To listen to one source whilst recording another, press the **SELECT** button to enter the menu system. Rotate the Control knob clockwise until the display shows 'REC OUTPUT'. Press **SELECT**. 'REC' is displayed, followed by the current setting (for example, 'REC TUNER'). Rotate the Control knob until the desired source is displayed. After a few seconds the display reverts to showing the volume level and you are ready to record.

The unit now sends the selected source ('Tuner' in the example above) to the **TAPE OUT** sockets while you listen to the same or an alternative source.

TAPE button operation ⑤

To play back the recording from a cassette deck attached to the **TAPE** input, press **TAPE**. 'TP-' followed by a two-letter abbreviation of the record out source is shown on the display (e.g. 'TP-CD'). Selecting this input overrides the other source selectors.

If the current record out is set to 'REC SOURCE' then the previous selected source is shown on the display. Pressing different source buttons on the front panel only changes the record output.

Tape mode can be exited by pressing **TAPE** again.

It is also possible to monitor a recording while it is being made, provided your cassette deck is a 3-head type. To do this, press **TAPE**. Switching this button in/out allows an A/B comparison between the source signal and the recorded signal.

Using the remote control

CR-389 Remote Control

The CR-389 remote control gives access to all functions available on the front panel of the A70. It also has controls to operate Arcam CD players, AM/FM tuners and DAB tuners. The remote control transmits Philips RC-5 type codes.

TUNER

These buttons are used to control tuner functions. Note that the **FM/DAB** lights indicate into which mode you are switching the remote control. The lights only illuminate for five seconds to conserve battery power. If neither light is illuminated this does not mean that the remote control is not working!

▲▼ (UP and DOWN)

These buttons do not apply to the A70.

ENTER

Performs the same function as the **ENTER** button on the front panel (see page 6).

SELECT

Performs same function as the **SELECT** button on the front panel. It allows you to use the remote's volume switch in the same way you use the control dial on the front panel – to adjust various amplifier settings (see page 8).

Note that pressing + corresponds to turning the Control knob clockwise, – to anticlockwise.

Source selection buttons

These operate in the same way as the source selectors on the front panel of your integrated amplifier.

Power/Standby

Toggles the amplifier between standby mode and full power mode. The power indicator light next to the power button on the front panel is red if the amplifier is in standby, amber while the amplifier is powering up (this only takes a few seconds) and green when the amplifier is powered up.

SP1 and SP2



These buttons allow you to select and deselect the main (**SP1**) and secondary (**SP2**) sets of speakers attached to your amplifier (see page 6).

DISP (display)

Cycles through the settings 'Bright', 'Off' and 'Dim'. Turning the display 'Off' generally gives a slight improvement in sound quality.

Volume and (mute)

Press + to increase volume or – to decrease the output volume of the amplifier.

Press  to mute the speaker connections and preamp outputs. Both tape outputs and the headphone socket remain active. Mute is disabled either by pressing  again, or by adjusting the volume.

You can use the remote's volume control in conjunction with the **SELECT** button to adjust balance, tone and amplifier settings.

CD controls

These offer basic controls of Arcam CD players



NOTE: Remember to install the two supplied AAA batteries before trying to use your remote control!

Do not place anything in front of the IR receiver on the left of the A70, or the remote control may not work.

Bi-wiring and bi-amping loudspeakers

Before you start

WARNING: Do not make any connections to your amplifier while it is switched on or connected to the mains supply.

Before switching on please check all connections thoroughly, making sure bare wires or cables are not touching the amplifier chassis (which could cause short circuits) and you have connected positive (+) to positive and negative (-) to negative.

Always ensure that the volume control on your amplifier is set to minimum before starting these procedures.

Bi-wiring your loudspeakers

Bi-wiring improves the sound of your system because it divides the high and low frequency signal currents into separate speaker cables. This avoids signal distortions arising from the high and low frequency currents interacting with one another within a single cable, as in conventionally wired systems.

You will need:

Speakers – with four input terminals each: these will be marked **HF** (High Frequency) and **LF** (Low Frequency).

Loudspeaker cables – two pairs of cables per loudspeaker (which may be joined at the amplifier end if your amplifier has only one pair of output terminals per channel), or a suitably terminated cable set (a loom, probably prepared by your dealer and capable of being used for bi-amping in one length).

How to bi-wire loudspeakers

1. Remove the terminal links on the rear of your loudspeakers

WARNING: This step is essential or damage to your amplifier may result which is not covered under warranty.

2. Connect the cables as shown in the diagram below, ensuring correct polarity at all times.

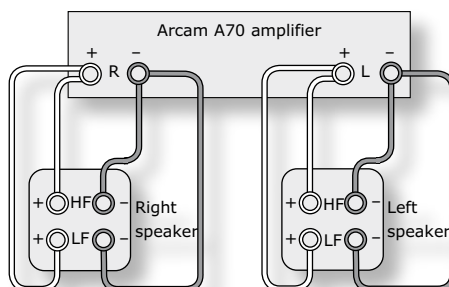

Bi-wiring using one set of connections on amplifier

Bi-amping your system

The performance of your system can be further enhanced over that achieved with bi-wiring, by extending the principle one stage further to include separate amplification for the low and high frequency drive units in each loudspeaker enclosure.

Connect the integrated amplifier to the high frequency (**HF**) terminals and connect the power amplifier to the low frequency (**LF**) terminals.

You will need:

Speakers – with four input terminals each (as with bi-wiring): these will be marked **HF** (High Frequency) and **LF** (Low Frequency).

Two amplifiers – one of these would be the A70 and the other an Arcam power amplifier (e.g. P90).

Loudspeaker cables – two pairs of cables per loudspeaker or a suitably terminated cable set (a loom, probably prepared by your dealer and capable of being used for bi-amping in one length).

Interconnect cables – one pair of high quality interconnect cables.

How to set up a bi-amped system

1. Remove the terminal links on the rear of your loudspeakers.

WARNING: This step is essential or damage to your amplifier may result which is not covered under warranty.

2. Connect the cables as shown in the diagram below, ensuring correct polarity at all times.
3. Use the interconnect cables to connect the **PRE OUT** sockets of the A70 to the corresponding **AUDIO IN** sockets of the power amplifier.

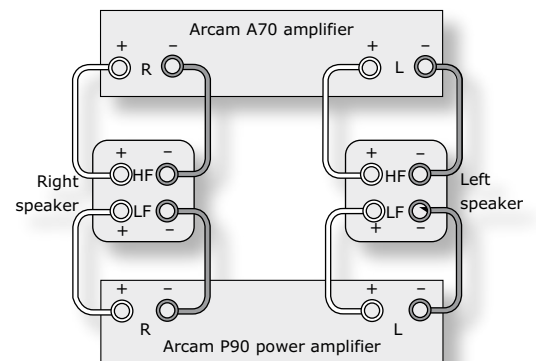

Recommended bi-amping configuration

Service information

Sound cuts out unexpectedly

Before returning an amplifier for repair, please check the following:

Heatsink protection

If the temperature of the internal heatsink rises above a safe level, a thermal cutout inside the amplifier operates, the power indicator on the front panel flashes and the protection system temporarily removes power to the speakers. The system resets after the heatsink has cooled down. Note that because of the high output voltage from a CD player, it is possible to drive the A70 at full power even though the volume is not set at maximum.

Transformer protection

The transformer is separately protected against thermal overload damage which may occur in exceptional circumstances. If the unit shuts down in this way, there is no indicator warning on the front panel: we recommend you disconnect the power supply and wait 30 minutes for the amplifier to completely cool. Power on in the normal way and the A70 will work normally.

Amplifier does not switch back on

The A70 and P90 amplifiers have a protection mechanism which is activated if you switch the unit on immediately after turning it off. If this mechanism activates, wait 30 seconds before switching back on again.

Technical specifications

Continuous power output, per channel	
Both channels, 8Ω, 20Hz–20kHz	50W
Distortion, 8Ω, 80% power, 1kHz	0.005%
Inputs	
Phono cartridge input sensitivity, MM	2.7mV
Line and tape inputs:	
Nominal sensitivity	250mV
Input impedance	22kΩ
Signal/noise ratio (CCIR)	98dB
Preamplifier outputs	
Nominal output level	545mV
Output impedance	<50Ω
General	
Power consumption (maximum)	450VA
Dimensions W x D x H (including feet)	430 x 330 x 85mm
Weight (net)	7.5kg
Weight (packed)	9.5kg
Supplied accessories	mains lead CR-389 remote control 2 x AAA batteries
E&OE	

Continual improvement policy

Arcam has a policy of continual improvement for its products. This means that designs and specifications are subject to change without notice.

NOTE: All specification values are typical unless otherwise stated.

Remote-control codes

The following table gives the IR-commands accepted by the A70.

Power commands

Command	Decimal Code
Power toggle	16-12
Power-on	16-123
Power-off	16-124

Source selection commands

Command	Decimal Code
PHONO select	16-1
AV select	16-2
Tuner select	16-3
DVD select	16-4
tape select	16-5
VCR select	16-6
CD select	16-7
Aux select	16-8

Volume control commands

Command	Decimal Code
Mute	16-13
Volume up	16-16
Volume down	16-17

Menu navigation commands

Command	Decimal Code
Select	16-37
Enter	16-87

Speaker control commands

Command	Decimal Code
Speaker 1 toggle	16-35
Speaker 2 toggle	16-39
Speaker 1 on	16-43
Speaker 1 off	16-44
Speaker 2 on	16-45
Speaker 2 off	16-46

Display control commands

Command	Decimal Code
Display	16-59

Note that the A70 also responds to code 20-53 (the **PLAY** command for an Arcam CD player). The A70 switches automatically to CD input on receiving this command.

Guarantee

Worldwide Guarantee

This entitles you to have the unit repaired free of charge, during the first two years after purchase, at any authorised Arcam distributor provided that it was originally purchased from an authorised Arcam dealer or distributor. The manufacturer can take no responsibility for defects arising from accident, misuse, abuse, wear and tear, neglect or through unauthorised adjustment and/or repair, neither can they accept responsibility for damage or loss occurring during transit to or from the person claiming under the guarantee.

The warranty covers:

Parts and labour costs for two years from the purchase date. After two years you must pay for both parts and labour costs. **The warranty does not cover transportation costs at any time.**

Claims under guarantee

This equipment should be packed in the original packing and returned to the dealer from whom it was purchased, or failing this, directly to the Arcam distributor in the country of residence.

It should be sent carriage prepaid by a reputable carrier – NOT by post. No responsibility can be accepted for the unit whilst in transit to the dealer or distributor and customers are therefore advised to insure the unit against loss or damage whilst in transit.

For further details contact Arcam at:

Arcam Customer Support Department,
Pembroke Avenue, Waterbeach, CAMBRIDGE,
CB5 9QR, England.

Telephone: +44 (0)1223 203200
Fax: +44 (0)1223 863384
Email: support@arcam.co.uk

Problems?

Contact your dealer in the first instance as they are there to help you. If your dealer is unable to answer any query regarding this or any other Arcam product please contact Arcam Customer Support on +44 (0)1223 203200 or write to us at the above address and we will do our best to help you.

On-line registration

You can register your Arcam product on line at: www.arcam.co.uk